

## MB RoofBar Flex 3

### Foot unit BU1 + FK24



106cm Skoda Octavia (estete) Kombi 98-

**DE** Montageanleitung

**GB** Fitting instructions

**SE** Monteringsanvisning

**FR** Instructions de montage

**RU** Инструкция по сборке

**PT** Instruções de montagem

**FI** Asennusohjet

**NL** Montagevoorschrift

**ES** Instrucciones de montaje

**IT** Istruzioni per componenti

**PL** Instrukcja montażu

## DE WICHTIG:

- Vor Erstgebrauch lesen.
- Montage nur nach dieser Vorlage durchführen.
- Vorlage im Fahrzeug mitführen.
- Geltende Rechte und Vorschriften müssen verfolgt werden bezüglich Verwendungsweise für Lastenträger und Zubehör.
- Vor der Montage und Anwendung des Produkts, diese Montageanleitung sehr genau durchlesen. Bei eventuellen Unklarheiten bitte setzen Sie sich mit Ihrem Händler in Verbindung.

## GB WARNING !

- Read these instructions carefully before using the product for the first time.
- Assemble and fit the product using these instructions only.
- Keep instructions in car.
- Be sure to follow the national rules and legislations in force regarding method of application of load carrier and accessories.
- Do not assemble or use this product unless you have understood the fitting instruction. If you have any questions, please contact your local dealer for further information.

## SE VARNING !

- Läs igenom anvisningen noggrant innan produkten tas i bruk.
- Montera endast enligt denna beskrivning.
- Monteringsanvisningen skall medföras i bilen.
- Gällande nationella lagkrav och föreskrifter skall följas vad avser användningssätt för lasthållare och tillbehör.
- Montera och använd inte produkten förrän du har förstått monteringsanvisningen.  
Vid eventuella oklarheter, kontakta återförsäljaren.

## FR IMPORTANT:

- A lire soigneusement avant la première utilisation
- Pour le montage, se conformer strictement aux présentes instructions
- Les instructions doivent nécessairement se trouver dans le véhicule
- Les arrêtés et lois nationaux en vigueur doivent être suivis lors de l'emploi du porte-bagages et de ses accessoires
- Ne pas assembler et ne pas utiliser le produit avant de lire les instructions de montage. Prendre contact avec le fournisseur lors de problèmes éventuels.

## FI TÄRKEÄÄ:

- Luettava ennen ensimmäistä käyttöönottoa.
- Asennus vain tämän ohjeen mukaan.
- Pidettävä mukana ajoneuvossa.
- Taakkatelineiden ja niiden lisätarvikkeiden käyttöä koskevia kansallisia lakeja ja muita säännöksiä on aina noudatettava.
- Älä asenna äläkä käytä tuotetta ennen kuin olet ymmärtänyt asennusohjeet. Ota yhteys jälleenmyyjään epäselvissä tapauksissa.

## NL BELANGRIJK:

- Voor gebruik goed doorlezen.
- Montage alleen volgens dit voorbeeld uitvoeren.
- Montagevoorschrift in de auto bewaren.
- Wettelijke regels en voorschriften ten aanzien van gebruik van alle dragers en accessoires moeten in acht worden genomen.
- Dit produkt niet monteren en gebruiken voordat het montagevoorschrift geheel duidelijk is. Wend U met eventuele vragen tot de plaatselijke dealer.

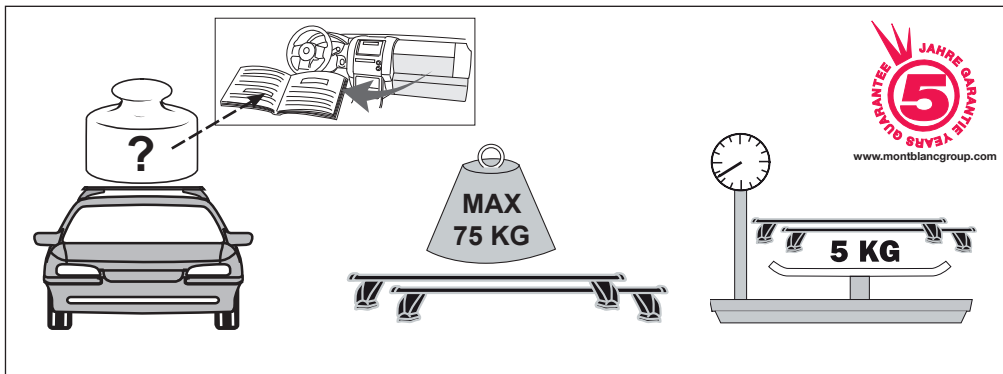

## ES IMPORTANTE:

- Leer antes del primer uso.
- Realizar el montaje unicamente conforme a estas instrucciones.
- Llevar las instrucciones en el vehículo.
- Reglas nacionales exigidas e instrucciones vigentes tienen que ser cumplidas al respecto del modo de uso de carga equipajes y accesorios.
- No monte o utilice este producto hasta que haya comprendido las instrucciones de montaje. Si tiene alguna pregunta, por favor pongase en contacto con su distribuidor para más información.

## IT INFORMAZIONI:

- Leggere accuratamente le istruzioni prima di usare il prodotto per la prima volta
- Adattare la ruota seguendo solo queste istruzioni.
- Tenere le istruzioni in auto
- Assicurarsi di seguire le norme nazionali e le leggi in vigore riguardanti il metodo di applicazione del portapacchi e accessori
- Non assemblare o usare questo prodotto salvo aver capito le istruzioni per l'uso. Per qualsiasi domanda, contattare il rivenditore locale per ulteriori.

## RU Предупреждение!

- Внимательно прочитайте инструкцию перед использованием продукта в первый раз
- Установите багажную систему, только используя инструкцию
- Держите инструкцию в машине
- Удостоверьтесь, что способ применения багажной системы и аксессуаров не противоречит Законодательству РФ
- Не собирайте и не используйте продукт, пока вы не поймете инструкцию по установке. Если в процессе установке у Вас возникли вопросы, свяжитесь с Вашим продавцом для получения необходимой информации.

## PL Ważne:

- Przed pierwszym użyciem przeczytać.
- Montaż przeprowadzić zgodnie z niniejszą instrukcją.
- Instrukcję należy umieścić w samochodzie.
- Należy stosować się do obowiązujących przepisów dotyczących sposobu korzystania z bagażników i wyposażenia.
- Przed zamontowaniem i użyciem niniejszego produktu należy bardzo dokładnie przeczytać niniejszą instrukcję montażu. W przypadku niejasności należy porozumieć się ze sprzedawcą.

## PT Atenção:

- Ler antes de utilizar
- Realizar a montagem conforme estas indicações
- Recomendamos manter estas instruções no seu automóvel
- Cumprir as regras nacionais e respectiva legislação a respeito do modo de utilização de carga e acessórios
- Não montar ou utilizar este produto sem ter compreendido e entendido as instruções de montagem. Se tiver alguma questão queira por favor entrar em contacto com o distribuidor nacional.

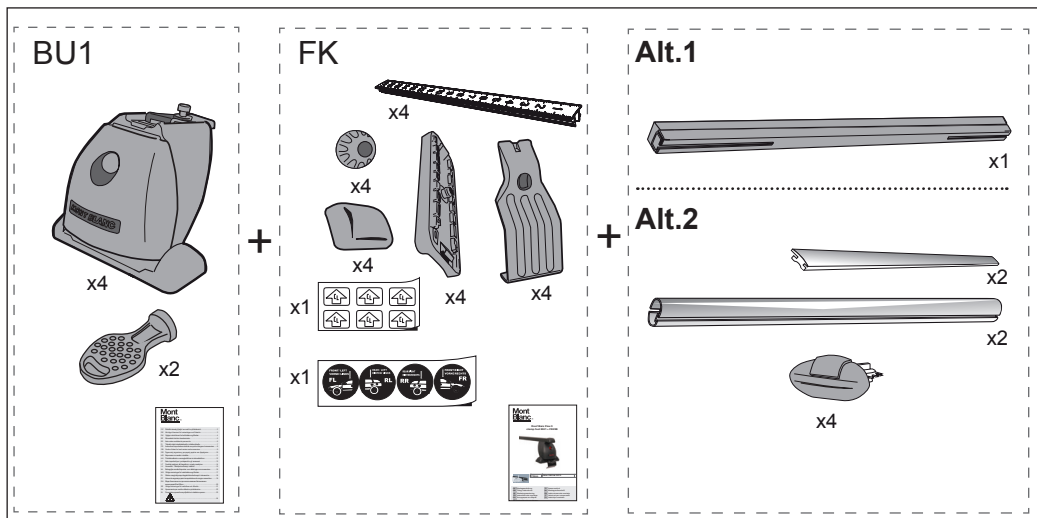

# 1.a

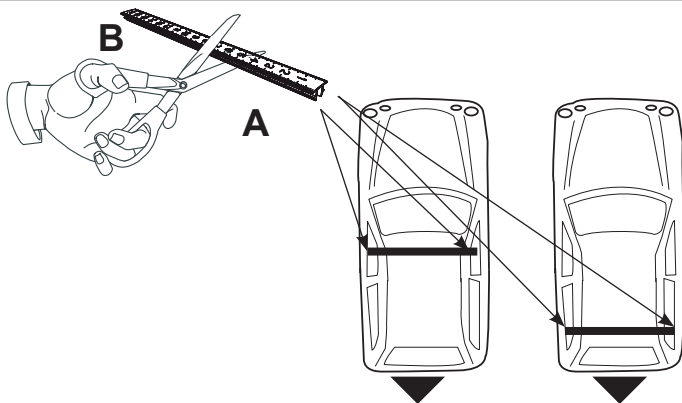

SKODA Octavia (estate)Kombi 98-

2 x 10,2 cm

2 x 8,0 cm

# 1.b

**OK!**

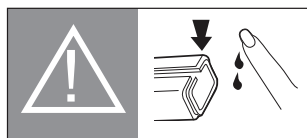

**A**

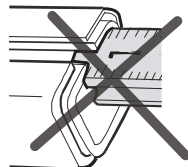

**OK!**

**A**



# 2

**A**

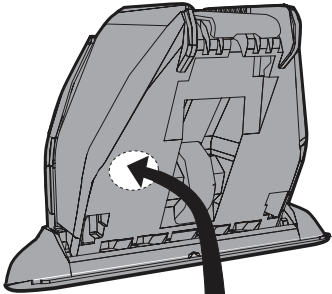

**C**

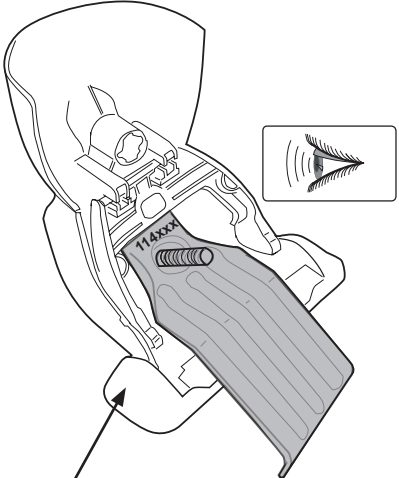

**FR = 114403**



**FL = 114403**



**RR = 114403**



**RL = 114403**

**B**

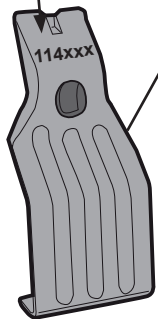

**D**

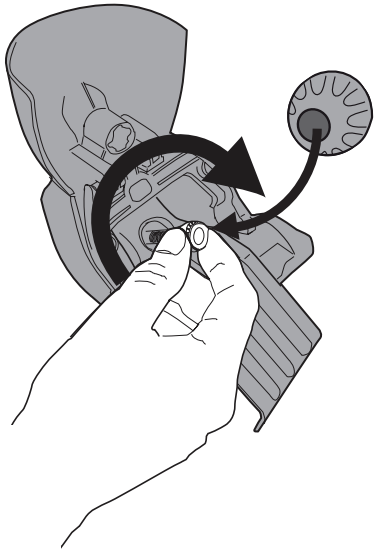

# 3

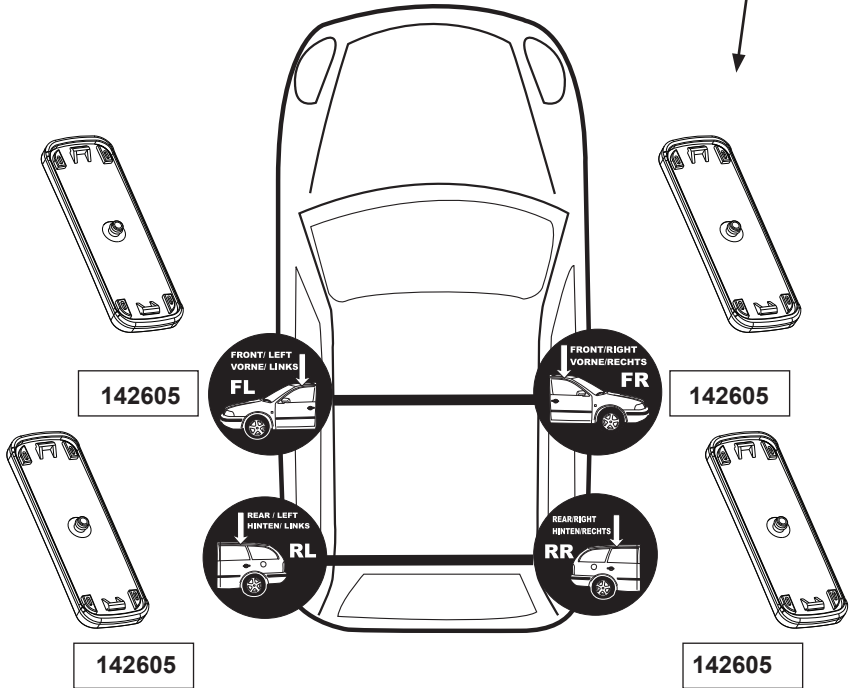
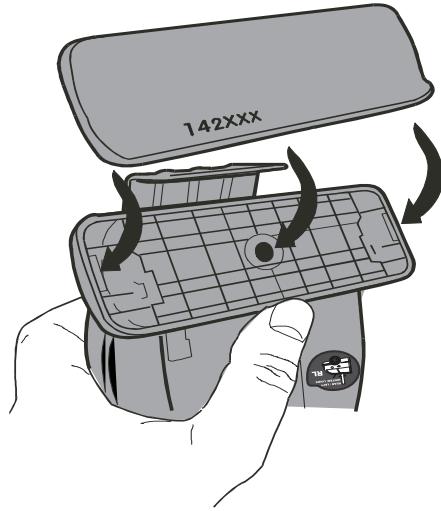

# 4

## Alt. 1

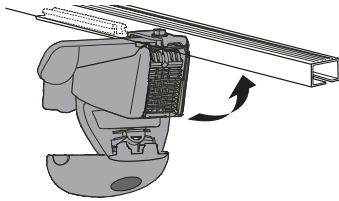
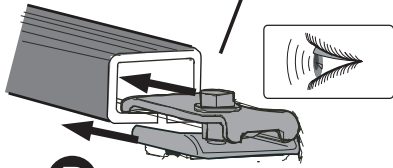
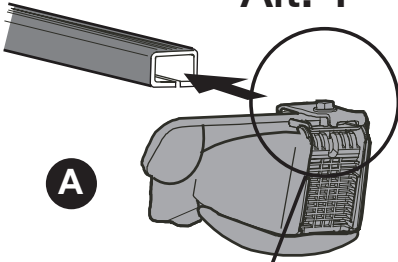

## Alt. 2

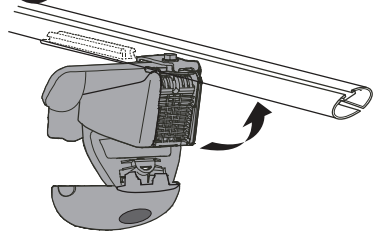
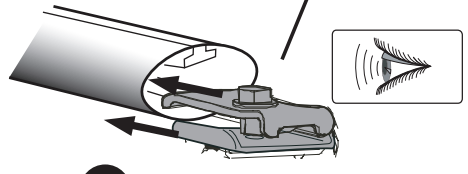
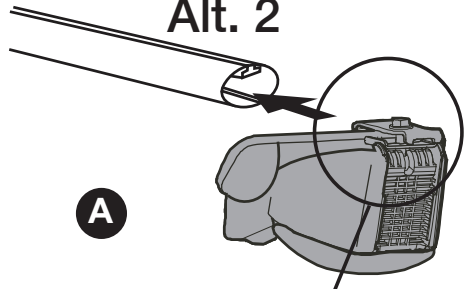

**C OK**

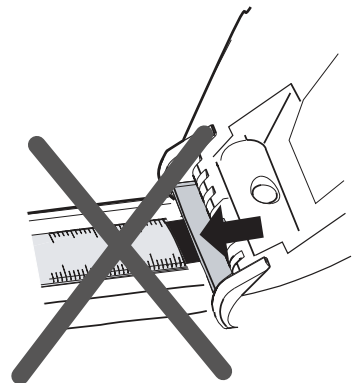
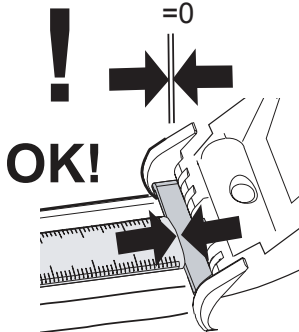
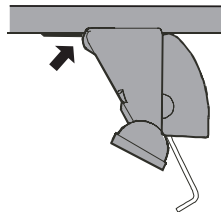

# 5

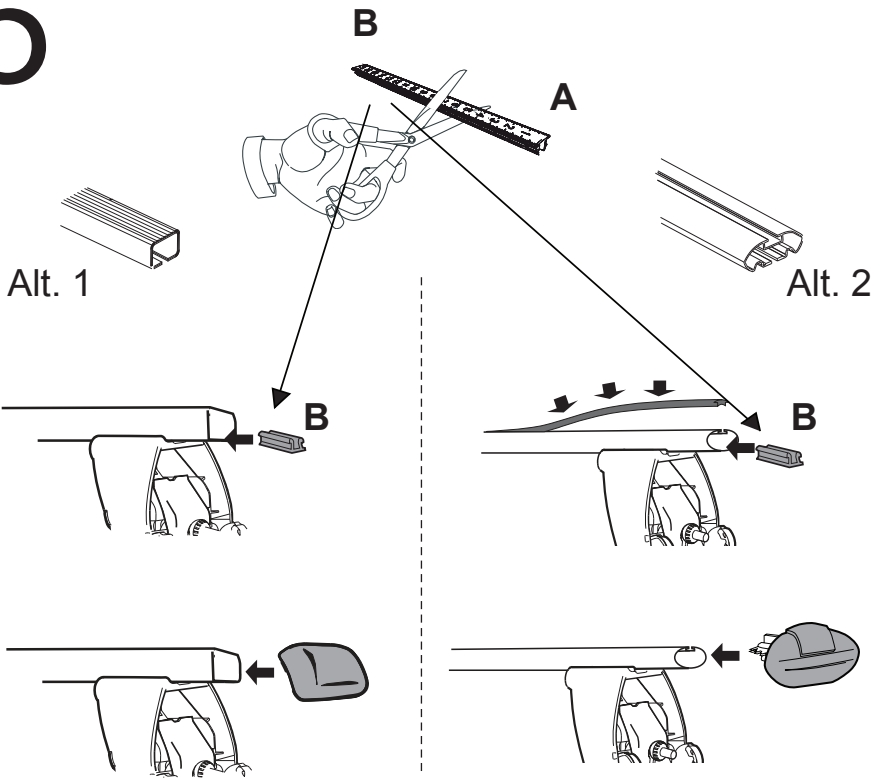

# 6

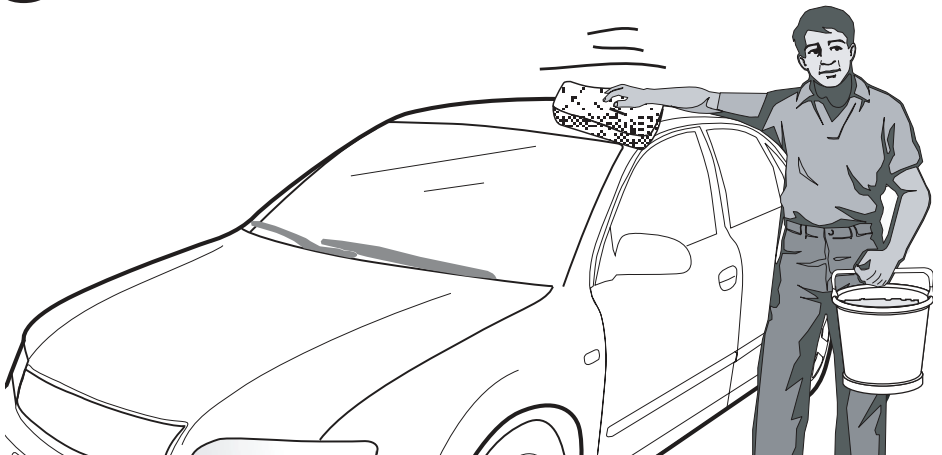



# 7

SKODA Octavia (estate)Kombi 98-

27,0

43,0

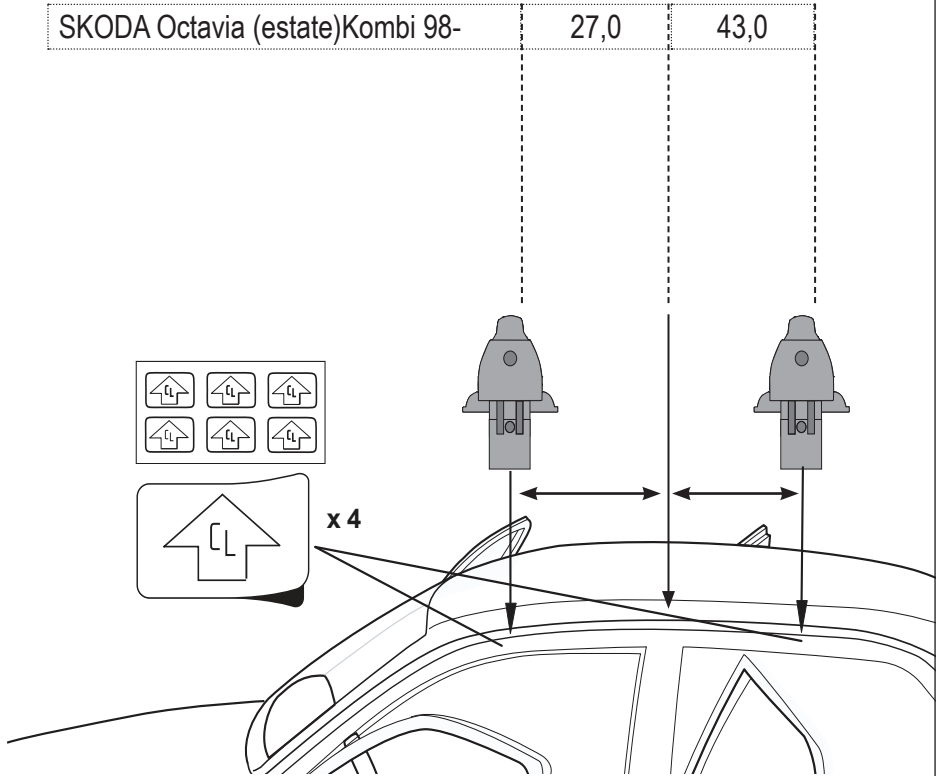

8

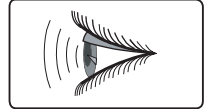
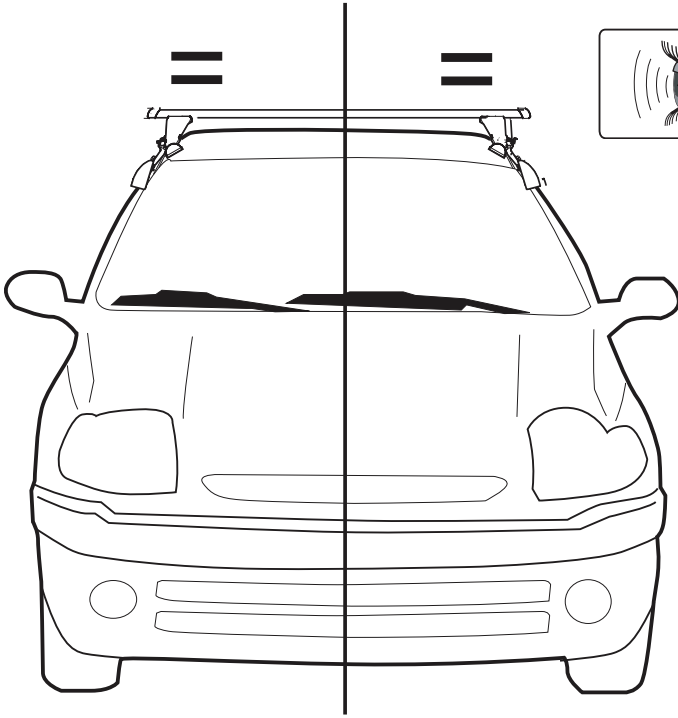

# 9

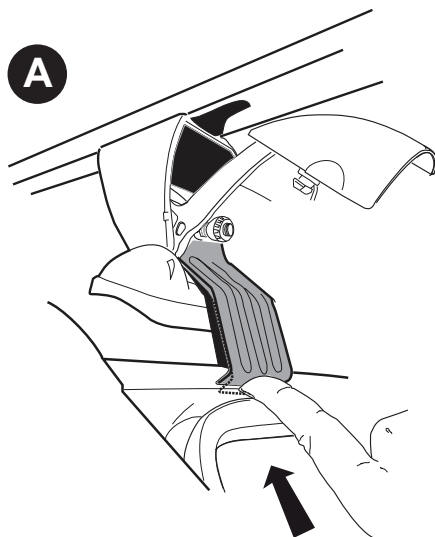

+

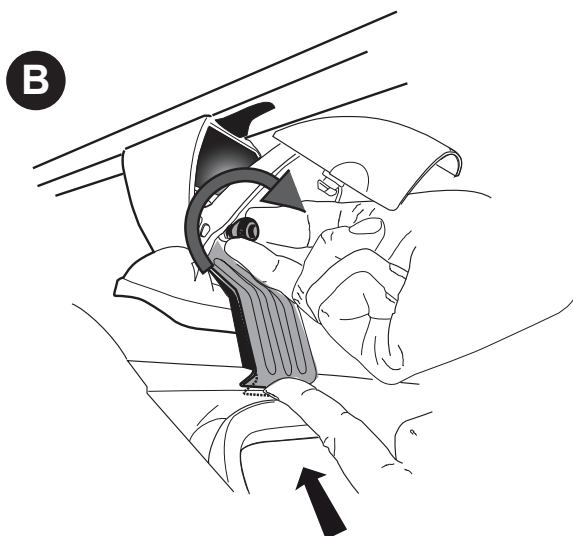

# 10

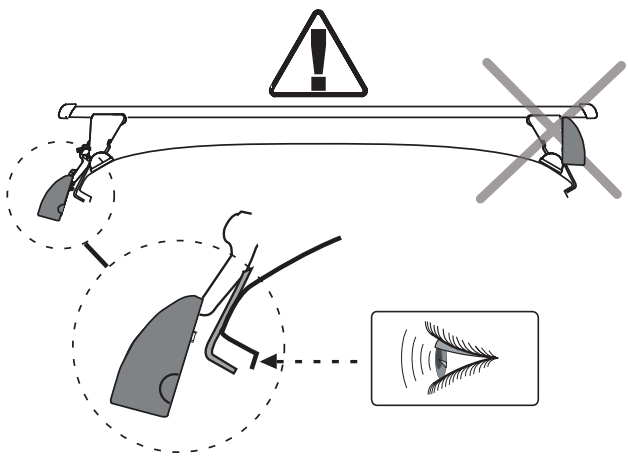
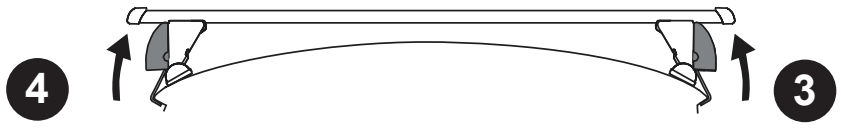
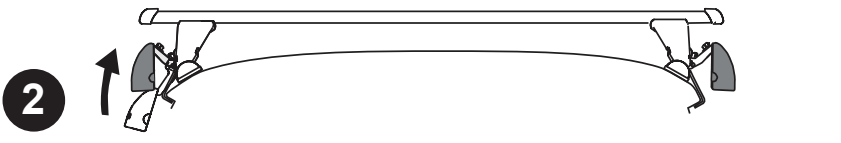
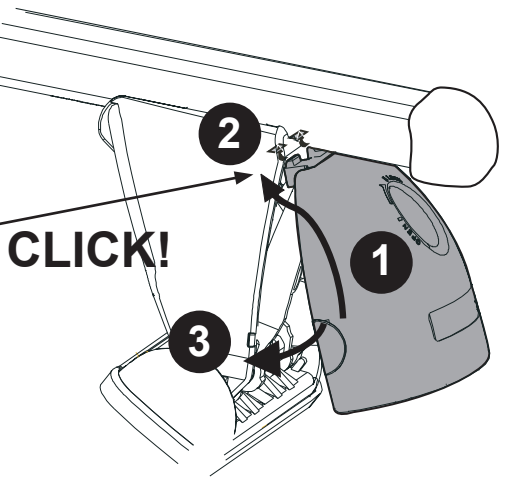
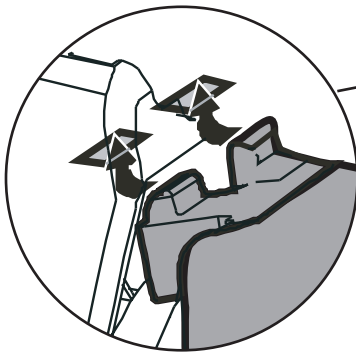

# 11

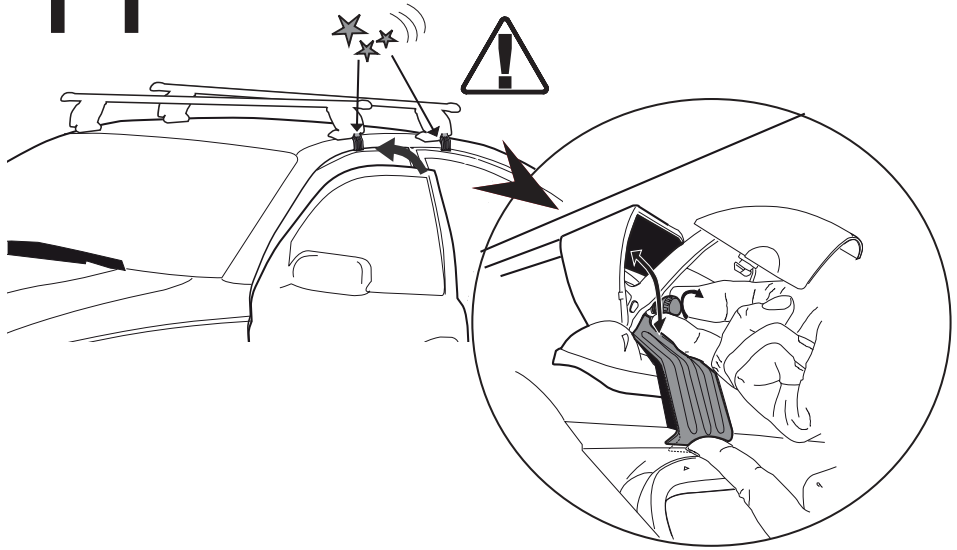

# 12

**CHECK!**

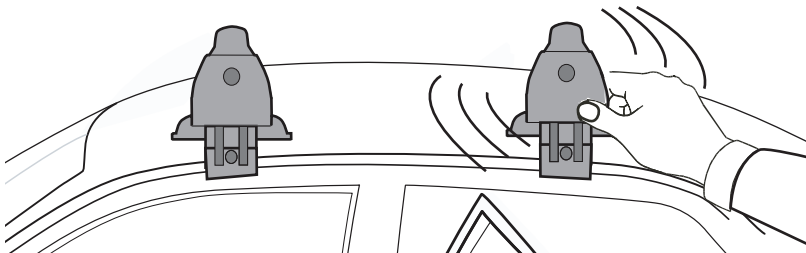
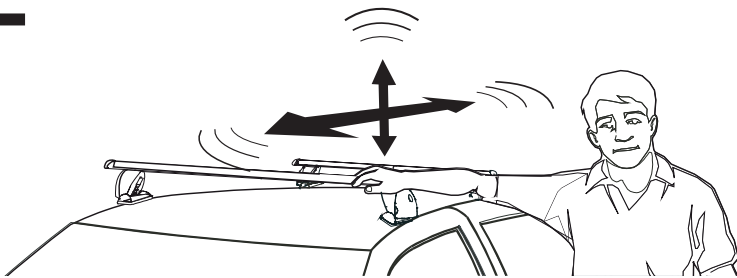

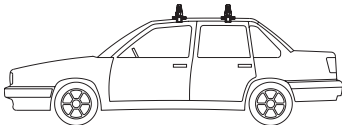

**CHECK!**

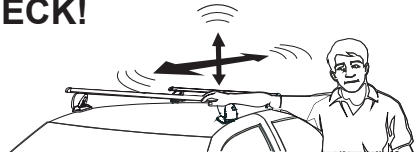

~20 km  
←

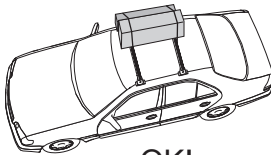
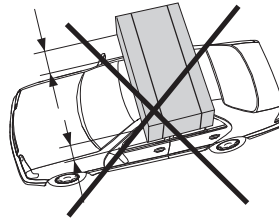
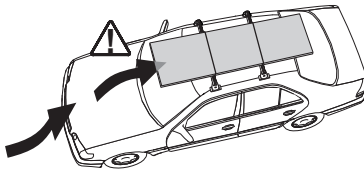

OK!

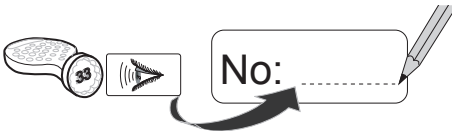
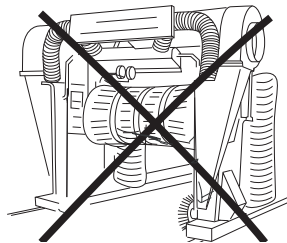
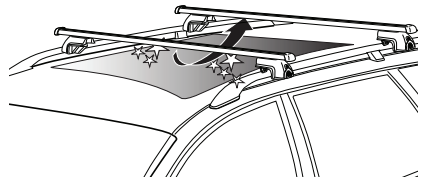
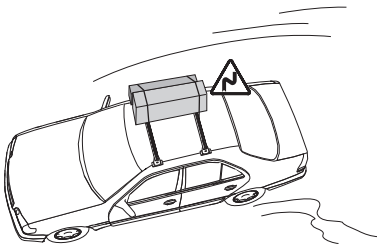
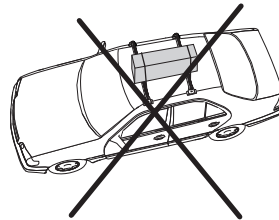

Ersatzteile • Spare parts • Reservdelar • Pièces de rechange • Запасные части  
 • Varosat • Onderdeel • Piezas de recambio • Pezzi di ricambio • Części zamienne  
 • Peças de substituição

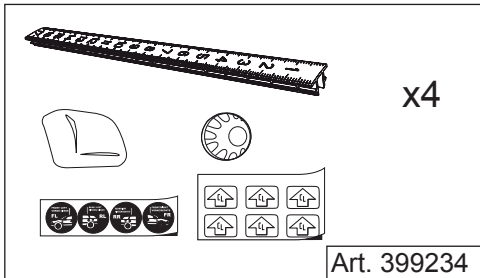
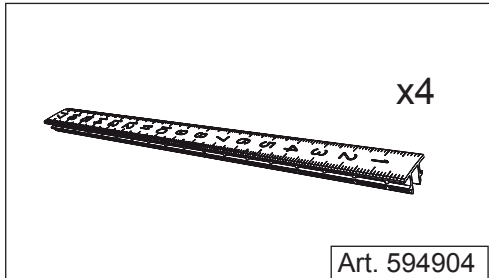
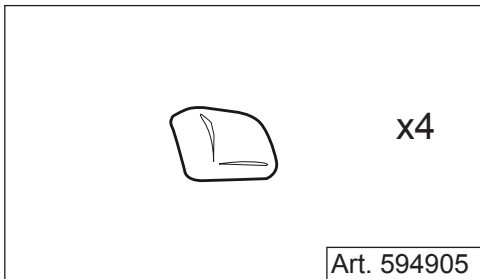
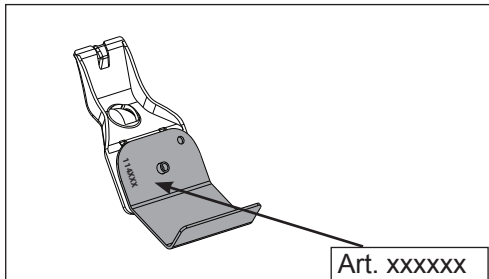
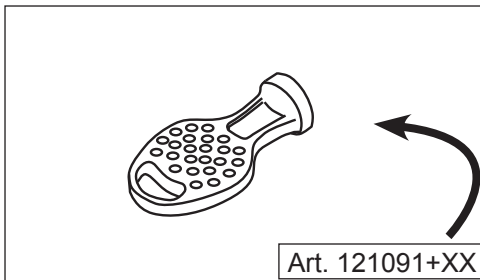
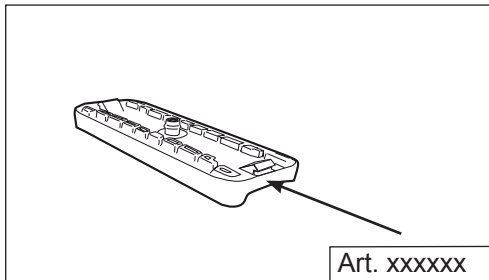

**Mont Blanc®**

Roof Bars Flex 3  
 clamp foot BUJ + FK228

118cm | Silver V40 Set 2012

DE: Montageanleitung	RU: Инструкция по монтажу
EN: Fitting instructions	UK: Інструкція по монтажу
FR: Mode d'emploi	PL: Instrukcja montażu
ES: Instrucción de montaje	PT: Instrução de montagem
IT: Istruzioni di montaggio	TR: Montaj talimatları
JA: 取り付け説明書	CS: Návod k montáži

www.montblancgroup.com



Full range of Roofbars



MB BikeCarrier RoofRush



MB BikeCarrier RoofSprint



MB RoofBox Altitude



MB BikeCarrier TowQuick



MB SnowSports Crest



Accessories



Accessories

**Mont  
Blanc**®

**Sweden:**  
 Mont Blanc Industri AB  
 Phone +46 33 222700

**UK:**  
 Mont Blanc Industri UK Ltd  
 Phone +44 1525 850800

**France:**  
 Mont Blanc France SAS  
 Phone +33 2 99211270

[www.montblancgroup.com](http://www.montblancgroup.com)